

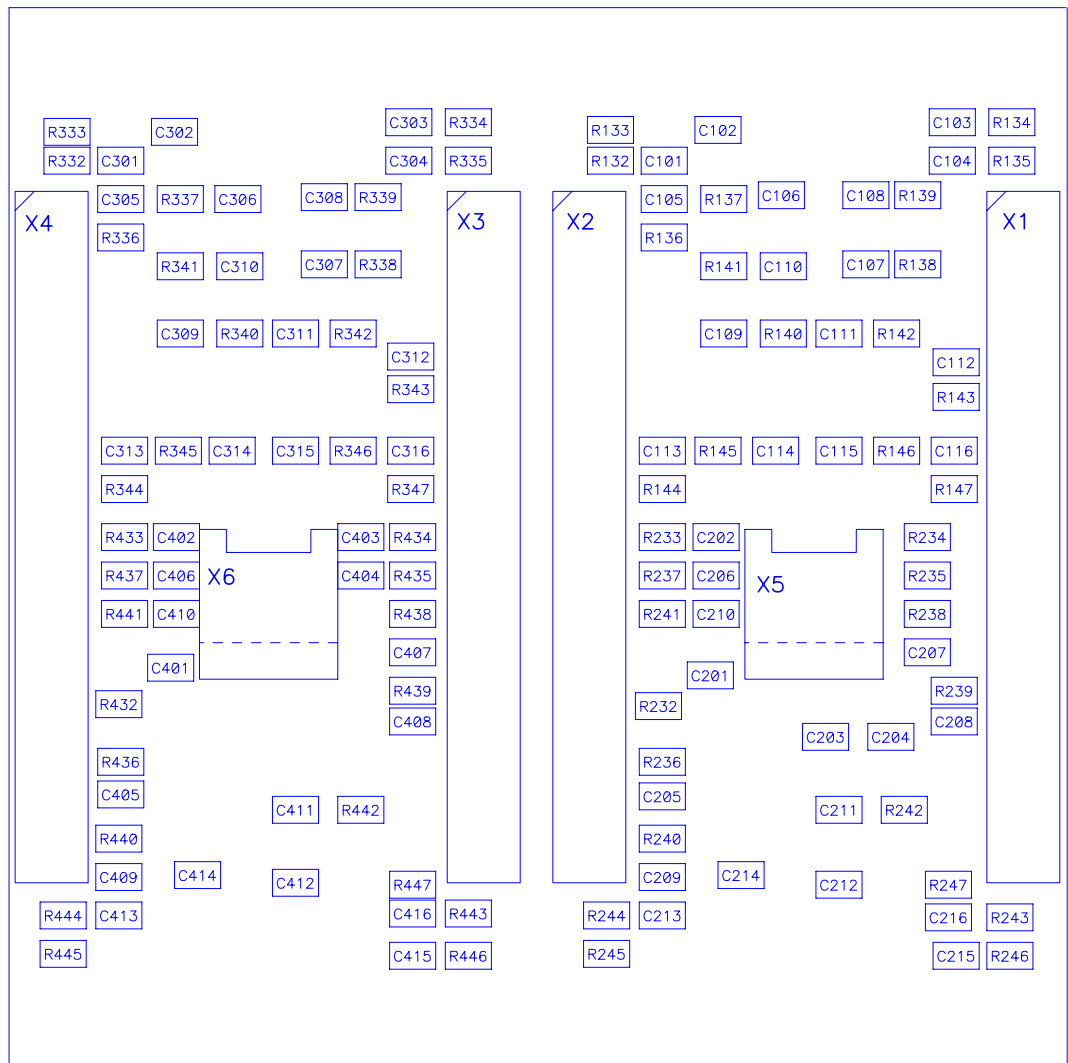

DES-TR BESTUECKUNGSPLAN (TOP)		Scale 1:2
Doc. Nr.: DES-TR .BPT		Rev: B
Date: 19.06.1997	checked by:	Drawn by <i>TM</i>
FILENAME: DES-PHOT.PCB		
Sheet 1 of 8		

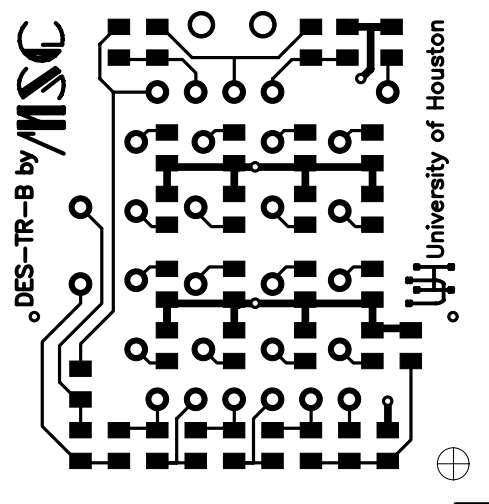

DES-TR BESTUECKUNGSPLAN (BOT)		Scale 1:2
Doc. Nr.: DES-TR .BPB		Rev:B
Date: 19.06.1997	checked by:	Drawn by <i>TM</i>
FILENAME: DES-PHOT.PCB		
Sheet 2 of 8		

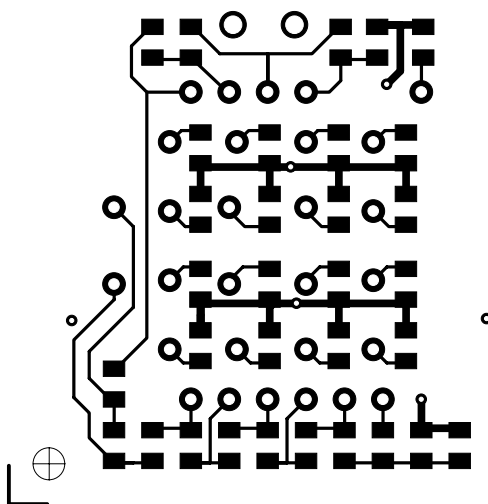
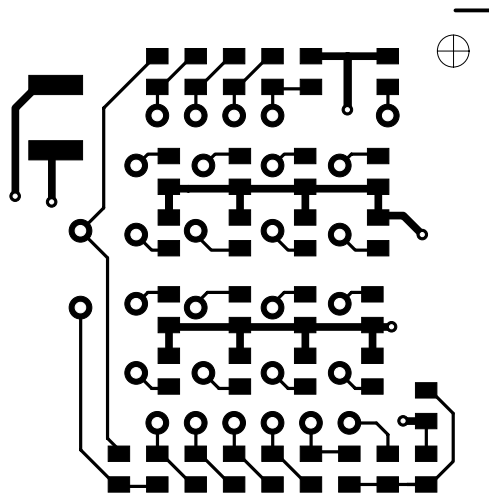
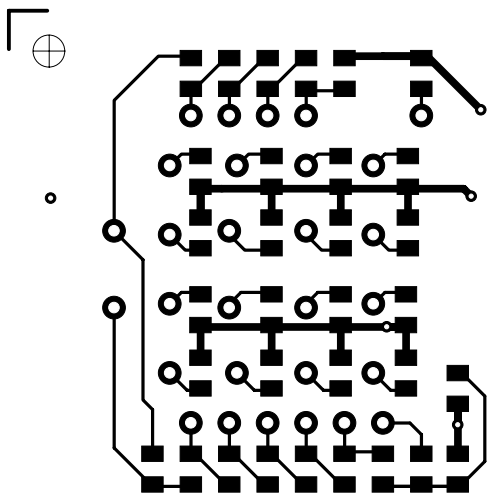

DES-TR TOP-LAYER		Scale 1:2
Doc. Nr.: DES-TR .TOP		Rev: B
Date: 19.06.1997	checked by:	Drawn by <i>TM</i>
FILENAME: DES-PHOT.PCB		
Sheet 3 of 8		

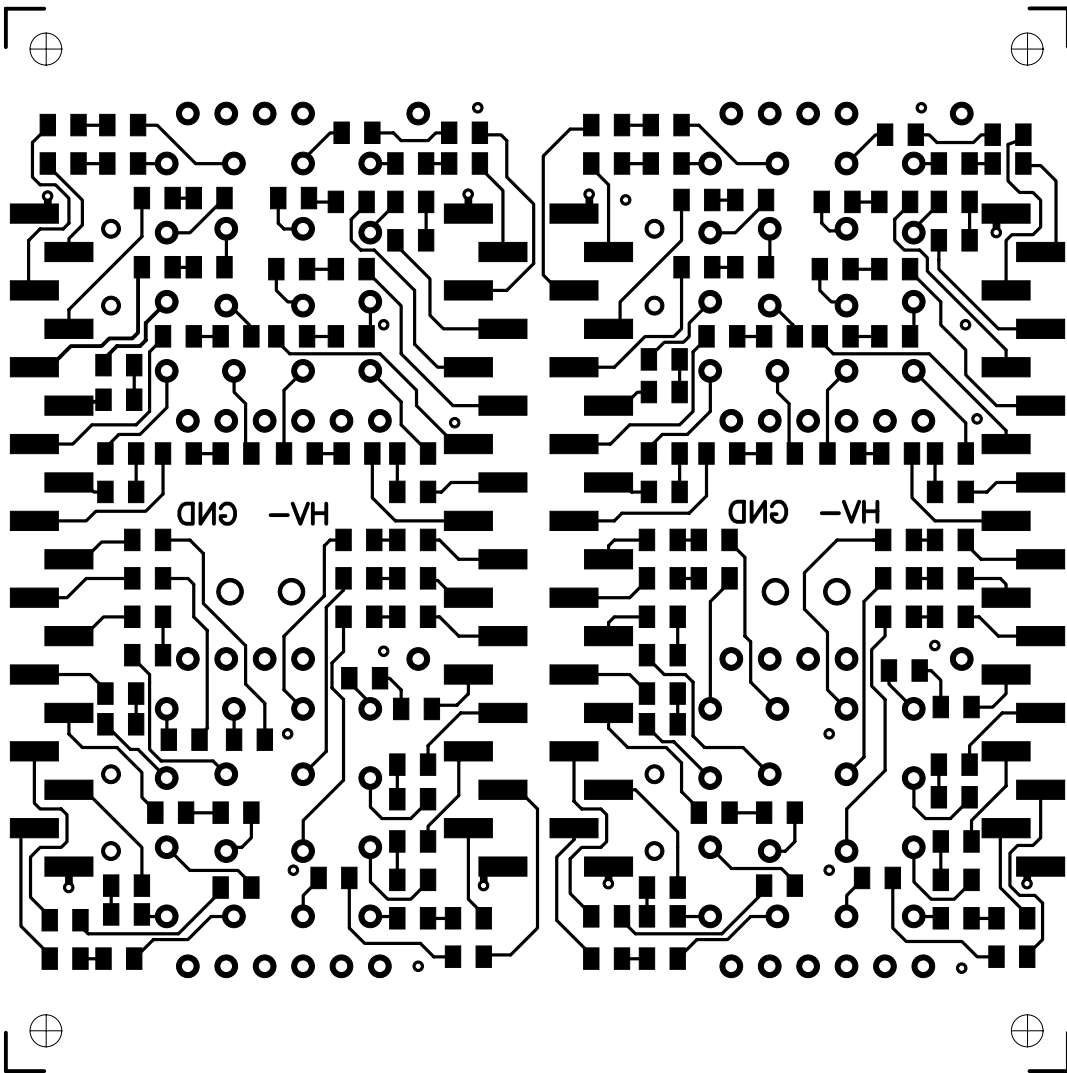

DES-TR BOTTOM-LAYER		Scale 1:2
Doc. Nr.: DES-TR .BOT		Rev: B
Date: 19.06.1997	checked by:	Drawn by <i>TM</i>
FILENAME: DES-PHOT.PCB		
Sheet 4 of 8		

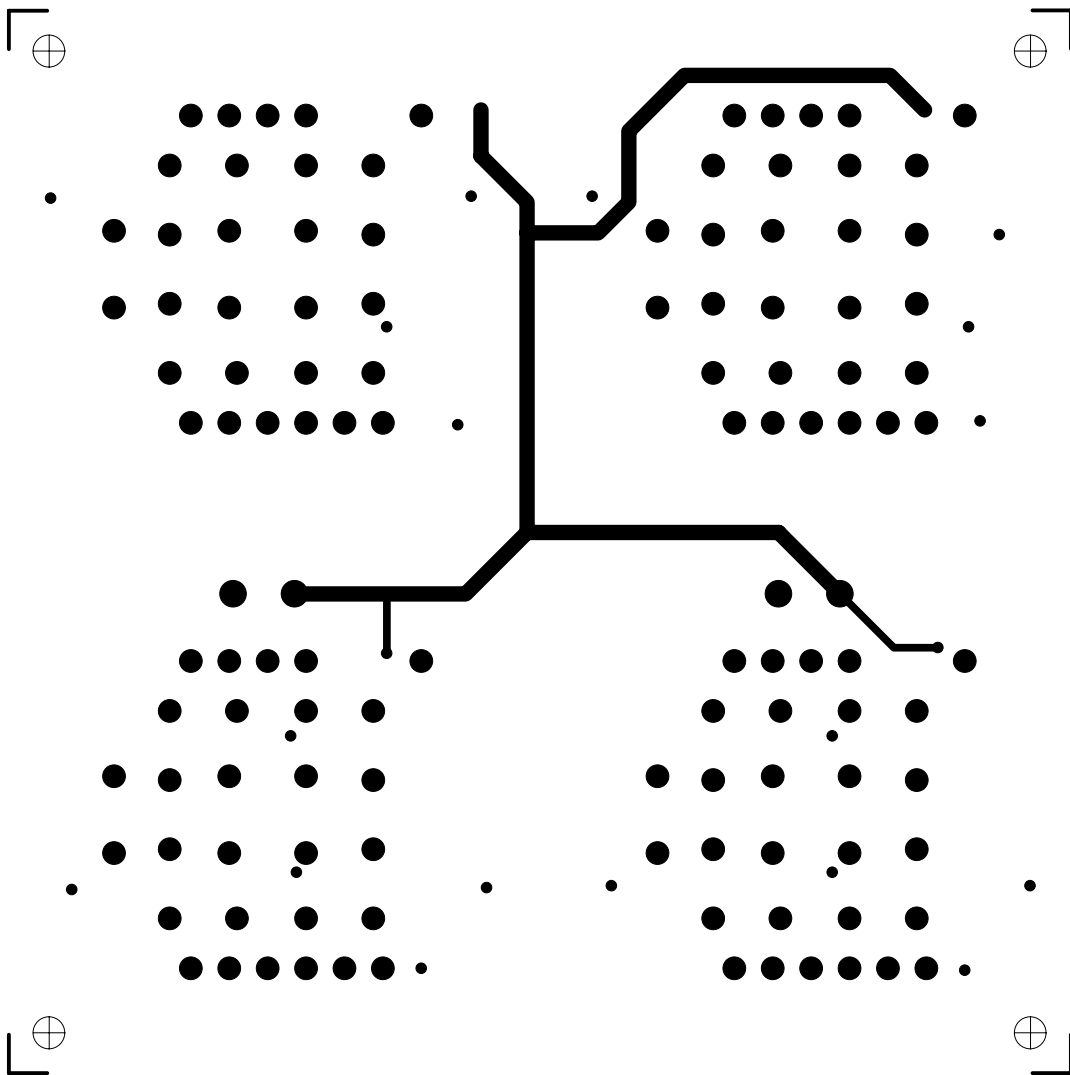

DES-TR MIDLAYER 1		Scale 1:2
Doc. Nr.: DES-TR .ML1		Rev:B
Date: 19.06.1997	checked by:	Drawn by <i>TM</i>
FILENAME: DES-PHOT.PCB		
Sheet 5 of 8		

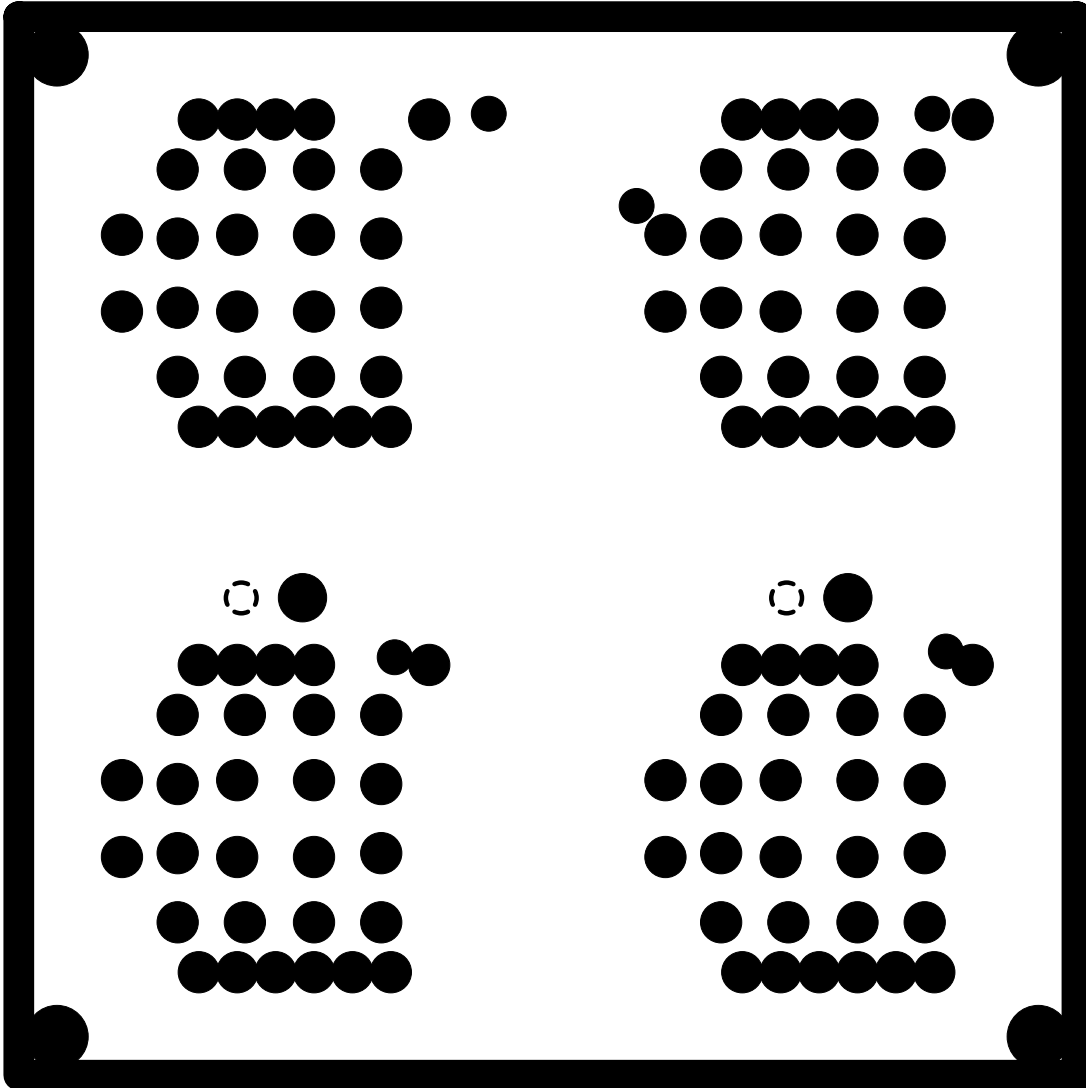

DES-TR GROUND-LAYER		Scale 1:2
Doc. Nr.: DES-TR .GND		Rev:B
Date: 19.06.1997	checked by:	Drawn by <i>TM</i>
FILENAME: DES-PHOT.PCB		
Sheet 6 of 8		

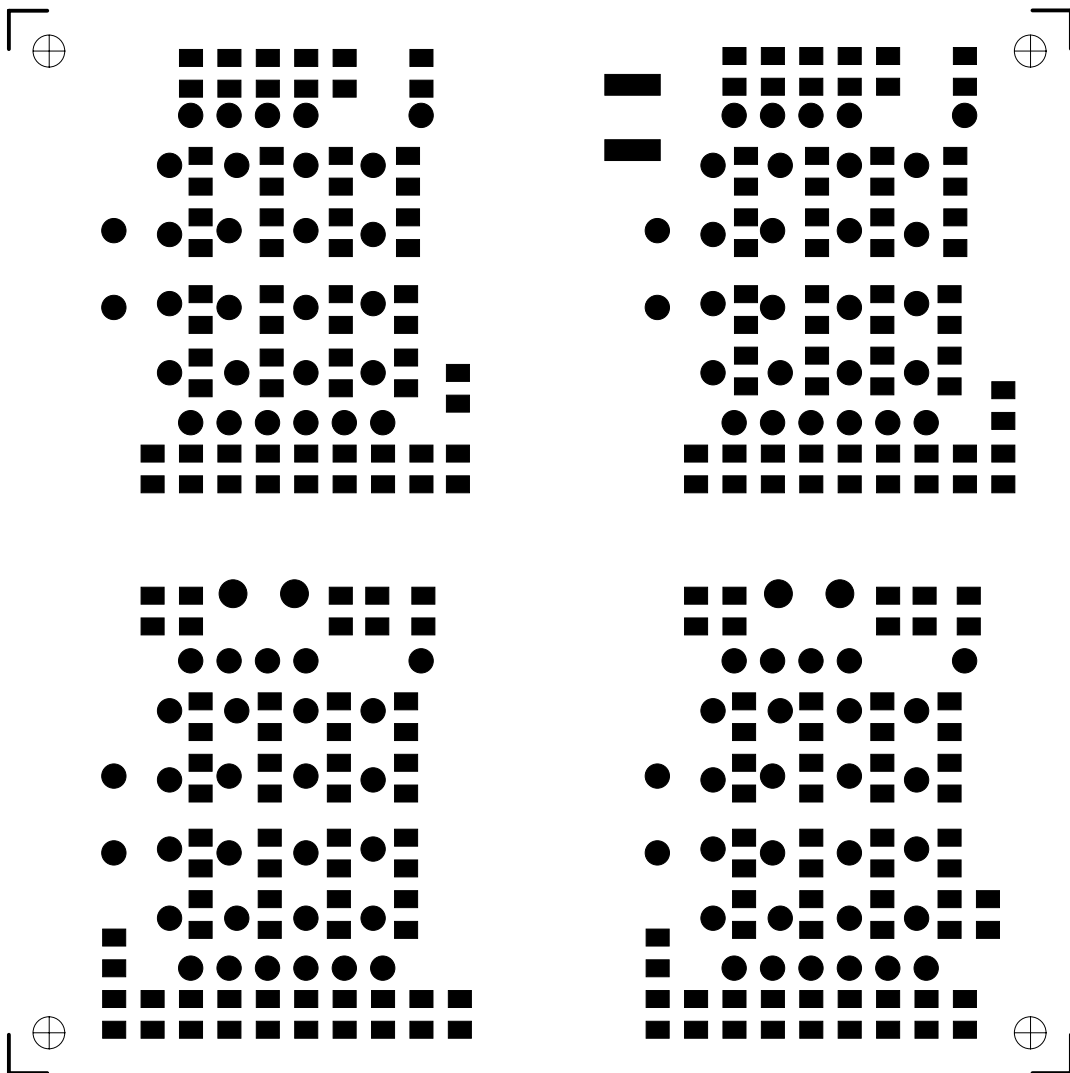

DES-TR LOETSTOP (TOP)		Scale 1:2
Doc. Nr.: DES-TR .SMK		Rev: B
Date: 19.06.1997	checked by:	Drawn by <i>TM</i>
FILENAME: DES-PHOT.PCB		
Sheet 7 of 8		

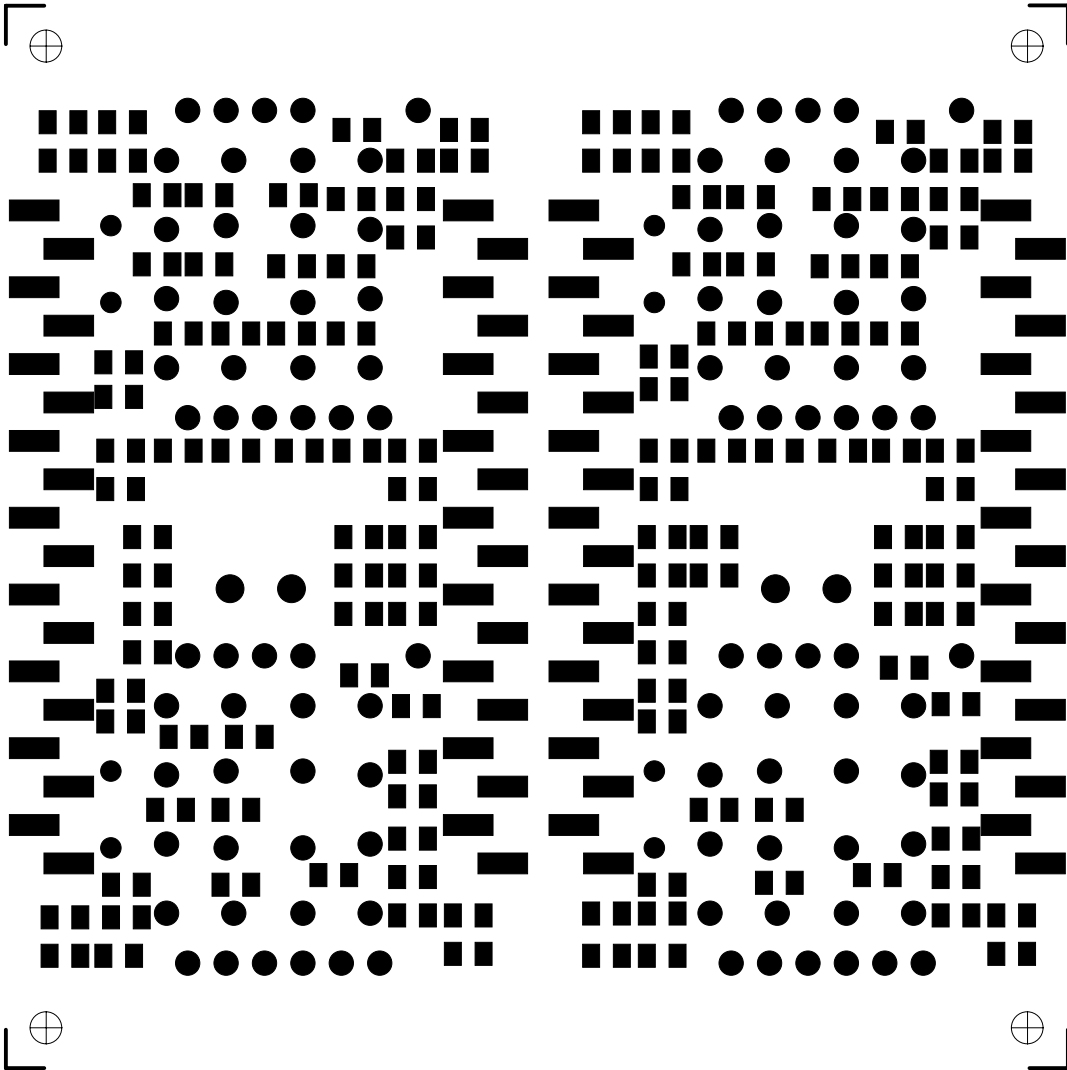

DES-TR LOETSTOP (BOTTOM)		Scale 1:2
Doc. Nr.: DES-TR .BSM		Rev: B
Date: 19.06.1997	checked by:	Drawn by <i>TM</i>
FILENAME: DES-PHOT.PCB	MSC Vertriebs GmbH	
Sheet 8 of 8		

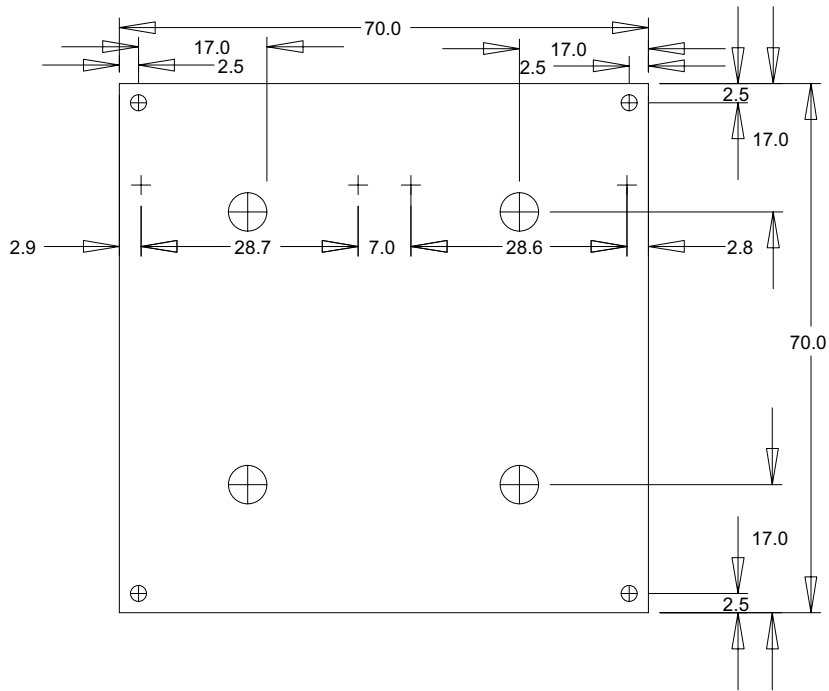

Aufbau der Leiterplatte

Lagen Nr.	Filename	Documenten Nr.	Dicke und Art der Verbindungsfolie	Dicke der Cu Kaschierung	Bemerkung
	DES-TR.NCY				BOHRDATEN
	DES-TR.SMK	DES-TR.SMK			LÖTSTOP B-SEITE
01	DES-TR.TOP	DES-TR.TOP	PREPREG	35um	LEITERBILD B-SEITE
02	DES-TR.GND	DES-TR.GND	KERN	35um	LEITERBILD LAGE02
03	DES-TR.ML1	DES-TR.ML1	PREPREG	35um	LEITERBILD LAGE03
04	DES-TR.BOT	DES-TR.BOT		35um	LEITERBILD L-SEITE
	DES-TR.BSM	DES-TR.BSM			LÖTSTOP L-SEITE

PLA DES TR-B		SCALE 1:1	
Doc. Nr.: 6596			
Date: 16.06.1997	checked by:	drawn by: TMA	
Filename: 6596.DS4	MSC Vertriebs GmbH		
Sheet 9 of 9			